

**ALLEN & HEATH**

**GL2200**

Dual Function Audio Mixing Console

**USER GUIDE**

PUBLICATION: AP3388

## **LIMITED ONE YEAR WARRANTY**

This product has been manufactured in the UK by ALLEN & HEATH and is warranted to be free from defects in materials or workmanship for period of one year from the date of purchase by the original owner.

To ensure a high level of performance and reliability for which this equipment has been designed and manufactured, read this User Guide before operating.

In the event of a failure, notify and return the defective unit to ALLEN & HEATH or its authorised agent as soon as possible for repair under warranty subject to the following conditions:

### **CONDITIONS OF WARRANTY**

1. The equipment has been installed and operated in accordance with the instructions in this User Guide.
2. The equipment has not been subject to misuse either intended or accidental, neglect, or alteration other than as described in the User Guide or Service Manual, or approved by ALLEN & HEATH.
3. Any necessary adjustment, alteration or repair has been carried out by ALLEN & HEATH or its authorised agent.
4. The defective unit is to be returned carriage prepaid to ALLEN & HEATH or its authorised agent with proof of purchase.
5. Units returned should be packed to avoid transit damage.

These terms of warranty apply to UK sales. In other territories the terms may vary according to legal requirements. Check with your ALLEN & HEATH agent for any additional warranty which may apply.

GL2200 User Guide AP3388 Issue 5. Copyright © 2004 Allen & Heath Limited. All rights reserved



This product complies with the European Electromagnetic Compatibility Directives 89/336/EEC & 92/31EEC and the European Low Voltage Directives 73/23/EEC & 93/68 EEC

**MANUFACTURED IN ENGLAND BY:**

**ALLEN&HEATH**

Allen & Heath Limited  
Kernick Industrial Estate  
Penryn, Cornwall, TR10 9LU. UK  
<http://www.allen-heath.com>

# CONTENTS

---

CONTENTS .....	3
INTRODUCTION, SERVICE, SAFETY & PRECAUTIONS .....	4
KEY FEATURES, THE RANGE & OPTIONS .....	5
CONNECTING POWER TO THE CONSOLE .....	6-7
EARTHING THE AUDIO SYSTEM .....	7
PLUGGING UP THE CABLES.....	8-9
ADJUSTING THE LEVELS .....	9
FLIGHTCASING THE CONSOLE.....	10
MONO INPUT CHANNEL .....	11-12
STEREO INPUT CHANNEL.....	13-14
STEREO RETURNS & AUX MASTER OUTPUTS .....	15
GROUP OUTPUTS .....	16
MODE SWITCHING.....	17
MASTER & MONITOR.....	18
OSCILLATOR/PINK NOISE & TALKBACK .....	19
APPLICATION – FRONT OF HOUSE.....	20
APPLICATION – STAGE MONITOR.....	21
APPLICATION – DUAL MODE.....	22
FRONT PANEL LAYOUT .....	23
REAR PANEL LAYOUT / SPECIFICATIONS & CONNECTIONS.....	24
INTERNAL LINK OPTIONS .....	25
CUE SHEETS .....	26-27
GL2200 BLOCK DIAGRAM.....	COVER

# INTRODUCTION

---

The **GL2200** continues ALLEN & HEATH's commitment to provide high quality audio mixing consoles engineered to meet the exacting requirements of today's audio business. It brings you the latest in high performance technology and offers the reassurance of over two decades of console manufacture and customer support.

This user guide presents a quick reference to the function, application and installation of the **GL2200**. We recommend that you read this guide fully before operating the console. For further information on the basic principles of audio system engineering please refer to one of the specialist publications available from bookshops and audio equipment dealers.

Whilst we believe the information in this guide to be reliable we do not assume responsibility for any inaccuracies. We also reserve the right to make changes in the interest of further product development.

## SERVICE AND TECHNICAL SUPPORT

---

Under normal conditions the **GL2200** does not require user maintenance or internal calibration. Any service work required should be carried out by qualified service personnel only.

We are able to offer further product support through our world-wide network of approved dealers and service agents. You can also access our Web site on the internet for information on our product range, assistance with your technical queries or simply to chat about audio matters. To help us provide the most efficient service please keep a record of the console serial number, and date and place of purchase to be quoted in any communication regarding this product.

### SAFETY WARNING!

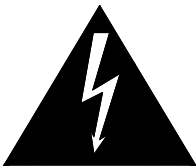

**Mains electricity is dangerous and can kill. Mains voltage is present within the console power supply.**

**Do not remove the power supply cover with mains electricity connected. To ensure your safety, mains earth is connected to the chassis through the power lead. Do not remove this mains earth connection.**

**To avoid the risk of fire, replace the mains fuse only with the correct value and type as indicated on the power supply unit.**

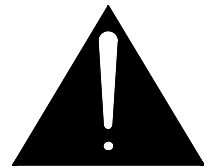

## GENERAL PRECAUTIONS

---

Your **GL2200** is ruggedly constructed to give many years of reliable operation. However, you will extend the life of the console and preserve its cosmetics by applying these simple common sense precautions.

- Avoid storing or using the mixing console in conditions of excessive heat or cold, or in positions where it is likely to be subject to vibration, dust, dirt or moisture.
- Do not use any liquids to clean the control surface of the console, a soft dry brush or dry lint-free cloth is ideal.
- Use only water or ethyl alcohol to clean the trim and scribble strips. Other solvents may cause damage to paint or plastic parts.
- The faders, switches and potentiometers are lubricated for life. The use of electrical lubricants on these parts is not recommended.
- Avoid using the console close to strong sources of electromagnetic radiation (e.g. video monitors, high power electric cabling): this may cause degradation of the audio quality due to induced voltages in connecting leads and chassis. For the same reason, always site any external power supply away from the unit.

# KEY FEATURES OF THE **GL2200**

---

The ALLEN & HEATH **GL2200** offers the user the versatility to quickly adapt to the exacting demands of live sound engineering today. The **GL2200** is developed from the very successful **GL2000** console, which included mode switching to quickly convert the console from Front-of-House to On-stage Monitor operation. In addition, the **GL2200** includes 4 subgroups, 6 independent aux sends, stereo mic/line channels, pink noise generator, 1kHz oscillator and lots more. It is built on the established tradition of innovative British design and manufacture. The **GL2200** is equally suited to home and studio recording. Features include:

- FOH/stage-monitor dual functionality
- 4 groups, 6 auxes
- Groups, L, R and Mono outputs on balanced XLR
- 12, 16, 24 and 32 channel frames
- 2 stereo line channels with mic capability
- 2 stereo returns with mutes, faders, EQ and Aux sends
- Mutes on Groups and L-R
- Channel direct outs
- 2-track send and return
- 4-band EQ with swept mids and in/out switch
- Input metering on each channel
- Phantom Power 48V, switchable on each channel
- Inserts on all mono inputs
- Inserts on Groups (auxes) and L-R outs
- Comprehensive AFL/PFL monitoring
- Pink noise generator for speaker setup
- Oscillator for equipment line up
- Talkback facility
- High-performance internal power supply with universal mains input voltage
- Built-in combiner to add external backup power supply
- Console lamp connector
- Sys-link™ expandability
- Rugged build quality

The console is constructed using zinc plated steel panels and 1.6mm thick metal side plates. Individual circuit board assemblies are accessible by removal of the steel base. A durable soft front armrest is provided for comfort. A channel top write-on strip is provided for channel marking. High quality reliable parts are used throughout. High performance op-amp and discrete circuits are used to ensure low noise and sonic purity. The internal power supply is a low noise switch mode unit that can be linked with an external DC power supply.

## THE RANGE

12, 16, 24 and 32 channel models

<b>GL2200-412</b>	10 mono, 2 stereo, 4 groups, 6 aux, 2 stereo returns, L, R, Mono sum
<b>GL2200-416</b>	14 mono, 2 stereo, 4 groups, 6 aux, 2 stereo returns, L, R, Mono sum
<b>GL2200-424</b>	22 mono, 2 stereo, 4 groups, 6 aux, 2 stereo returns, L, R, Mono sum
<b>GL2200-432</b>	30 mono, 2 stereo, 4 groups, 6 aux, 2 stereo returns, L, R, Mono sum

## OPTIONS

<b>GL2200-SL1</b>	Sys-link buss expander, one kit per console
<b>RPS11-3C</b>	3U rack mount power supply for backup
<b>002-225</b>	RPS11 to GL2200 DC cable assembly

# CONNECTING POWER TO THE CONSOLE

Refer to the **SAFETY WARNING** on page 4 of this User Guide. Read and understand the warnings and instructions printed on the rear panel of the console and printed here.



**Ensure adequate ventilation around the console. Do not cover the console or position it on soft furnishings during operation.**



**The console must be connected to 0V ground by either the a.c. mains input cable or by the EXTERNAL DC IN cable.**

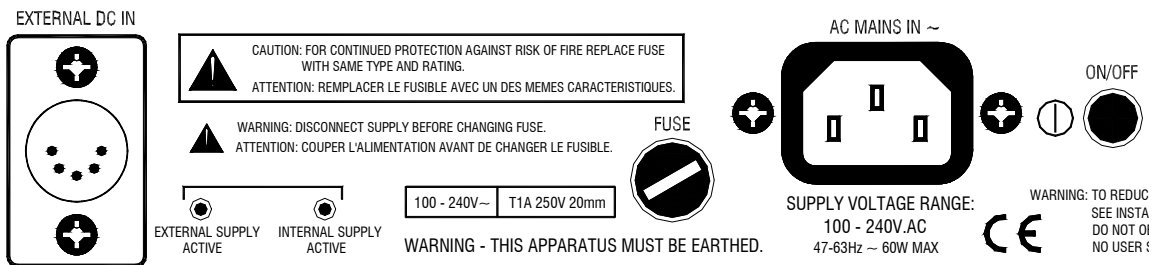

The **GL2200** console can be powered from either the internal power supply, from an external DC supply such as the Allen & Heath **RPS11**, or both together. The LED indicators on the rear panel illuminate to indicate which supply is active.

Normally the internal power supply will be used to power the console by the standard 3 pin IEC mains input connector. A mains cable with moulded mains plug suitable for the local supply is supplied. Check that the correct mains lead with moulded plug has been supplied with your console. Ensure that the IEC mains plug is fully inserted into the rear panel socket before switching on.

## POWER SUPPLY

The internal power supply for the **GL2200** is a switch mode supply and will operate from a wide range of mains input voltages. It produces the DC voltages required by the console. Before switching on your console, check that the ac mains fuse is of the correct type and rating. This is clearly marked on the rear panel of the console. Do not replace the fuse with any other type, as this could become a safety hazard and will void the warranty.

AC~ mains input voltage	Fuse value
100 - 230V ±10%	T 1A 250V 20mm

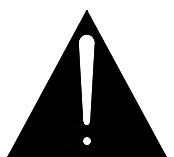

**CAUTION: For continued protection against the risk of fire, replace fuse only with the correct type and value.**



**The console power supply unit contains no user serviceable parts. Do not remove the cover. Refer servicing to qualified service personnel only.**

An external DC supply may be used instead of, or together with the internal supply. Use only recommended Allen & Heath power supplies or a supply approved by Allen & Heath. The use of alternative supplies is not recommended and may cause damage.

The pin connections for the **EXTERNAL DC IN** connector are specified below:

Pin	Voltage	Current
1	-16V	1.5A
2	Audio 0V	
3	Chassis 0V	
4	+16V	1.5A
5	+48V	0.1A

In the absence of an active 100V to 230V a.c. mains supply, the **GL2200** will automatically switch over to the external DC supply unit if connected.

Always turn connected power amplifiers down or off before switching the console on or off.



**In the event of an electrical storm, or large mains voltage fluctuations, immediately switch off and disconnect all power to the console.**

## EARTHING THE AUDIO SYSTEM

---

The console chassis is connected to mains earth via the power cable. Audio 0V is connected internally to the chassis and therefore mains earth. In this way all signal returns and connector shields are connected to mains earth at the console.

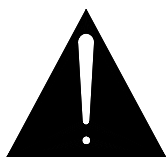

**To ensure safety, do not remove the earth connection from the AC mains plug or from EXTERNAL DC IN cable.**

For best performance it is important that the earth system is solid, clean and noise-free. To prevent mains-borne and external interference pickup from lighting equipment, motors and other mains powered equipment it is recommended that a separate 'clean' mains distribution outlet is used for the audio system.

All signal cables should have their screens connected to earth at the connector. If earth (ground) loop problems result in audible hum or buzz then disconnect the cable screen connection at one end, usually the destination end. This may be done within the cable plug or by operating the 'ground lift' switch if available on the connected equipment. Many DI boxes and power amplifiers include this facility.

# PLUGGING UP THE CABLES

The **GL2200** uses professional grade 3-pin XLR, 1/4" TRS jack and RCA PHONO sockets. Where possible use balanced connections to prevent noise and interference pickup especially on long cable runs. Avoid running audio cables next to AC mains, computer or lighting cables, near thyristor dimmer units or power supplies etc. The use of low impedance sources such as good quality microphones of 200 ohms or less significantly reduces interference pickup. Many problems can be avoided by taking time to check that all cables are correctly wired. Avoid reversing + and - on balanced connections as this will result in out of phase signals (reverse polarity) causing signal cancellation effects. This situation is particularly common in multi-microphone mixing. Use professional quality cable and carefully soldered connections. The following wiring convention is used:

XLR	
Pin 1	0V earth shield
Pin 2	+ / hot / signal
Pin 3	- / cold

1/4" TRS jack	
Tip	+ / hot / signal / left / send
Ring	- / cold / 0V / right / return
Sleeve	0V earth shield

## CABLE WIRING

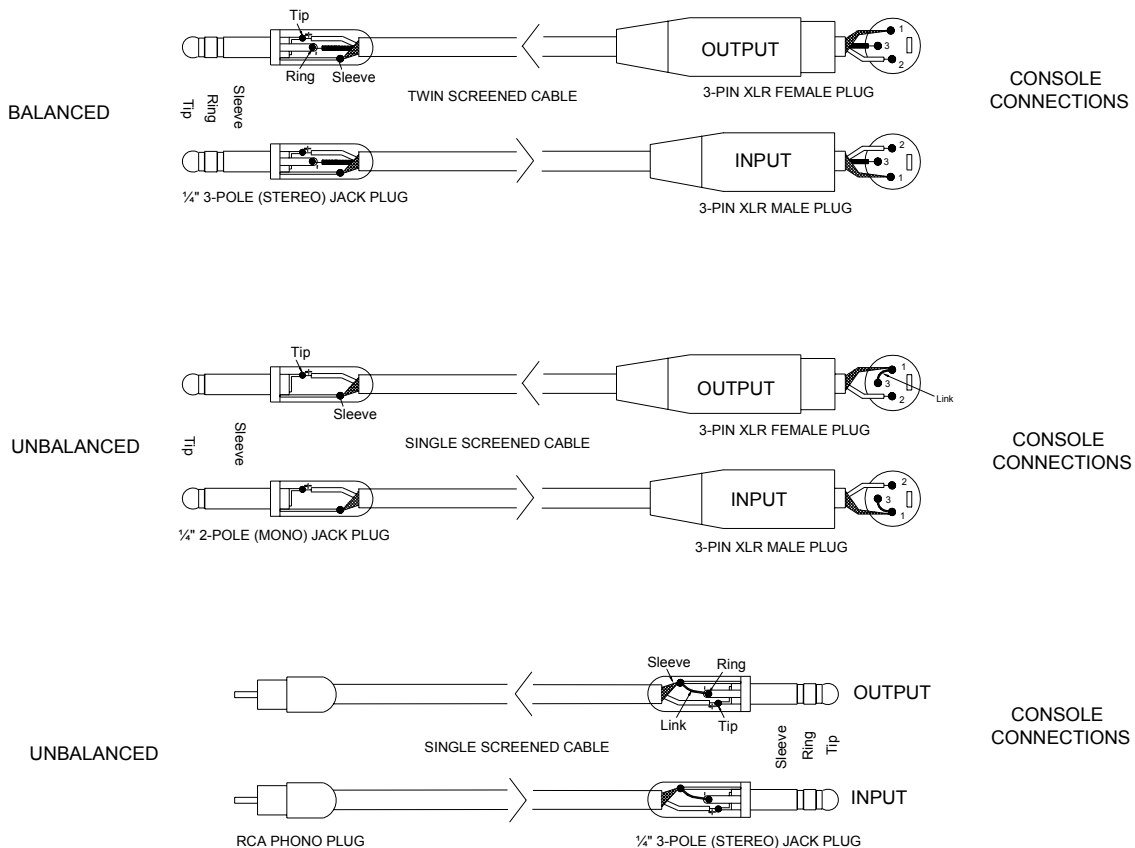

To connect an unbalanced source to a balanced console input, link the cold input (XLR pin 3 or jack ring) to 0V earth (pin 1 or jack sleeve) at the console. To connect a balanced console output to an unbalanced destination link the cold output to 0V earth at the console.

**Deselect input channel +48V when inputs are connected to non-phantom powered, mic, line or unbalanced sources.**



## CONNECTING CHANNEL INPUTS

Both microphone and line sources such as keyboards, replay devices and effects processors can be plugged into either the jack or XLR input for convenience. The channel accepts a wide 70dB range of source levels. The balanced 3-wire input provides the best immunity to interference pickup on long cable runs.

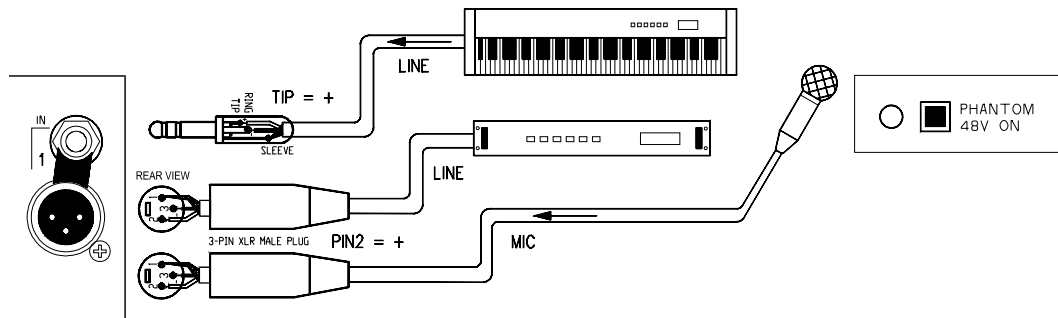

## CONNECTING TO INSERTS

You do not need to plug anything into the insert socket for normal operation. You may, however wish to insert a signal processor such as a compressor/limiter or noise gate into the signal path to prevent excessive peaks or to cut down source noise. The insert lets you do this by breaking the signal path after the input pre-amp and before the EQ in the channel input or before the fader in the Group and L-R section. Use a Y-lead or suitable TRS jack lead to connect to the external processor. The insert operates at 0dBu line level in the channel input and -2dBu in the Group and L-R section. Adjust the processor input and output levels for optimum signal level.

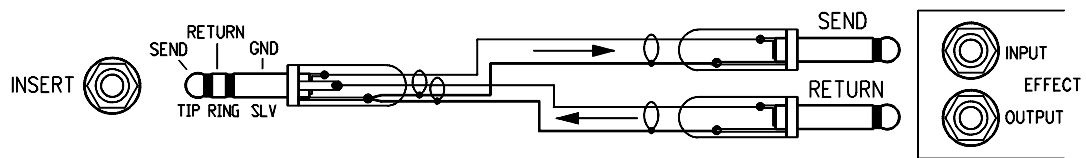

## CHANNEL DIRECT OUTPUTS

The channel direct output taps the signal off post-fader (pre-fader if the internal link option is changed) for connection to external processing or recording equipment. This is ideal for multitrack recording during a live performance. Here each channel can be recorded on a separate track for mixdown later. The output is impedance balanced on TRS jack. This means that you get the benefit of interference immunity when connecting to outboard equipment with balanced inputs. You can, of course, also connect to unbalanced equipment. The signal operates at nominal 0dBu line level.

# ADJUSTING THE LEVELS

For best performance it is important that the connected source signals are matched to the “normal operating level” of the console. Similarly the console outputs should be correctly matched to the operating levels of the connected amplifiers and destination equipment. If too high, the signal peaks will be clipped resulting in a harsh distorted sound, and if too low, the signal-to-noise ratio is reduced resulting in excessive background hiss.

For best results, operate the console with the meters averaging ‘0’ or just below and allowing the loudest passages and occasional peaks into the ‘yellow’. Reduce the gain if the peak indicators flash (red). The **GL2200** provides +4dBu output level at the XLR outputs for a meter reading of 0VU. It is advisable to adjust the power amplifier input gain or fit an attenuator pad if normal console operation results in an output level too high for the connected amplifier. Normal operation should give rise to fader levels around the ‘0’ mark.

The **GL2200** has an advanced PFL (pre-fade listen) / AFL (after-fader listen) and channel metering system to let you listen to and check the level of signals at different points in the signal path without affecting the main outputs. Use the channel **PFL** switches to set up the input **GAIN** controls to read an average ‘0’ (yellow LED). Signal activity is always shown on the channel meters regardless of fader position. The green ‘SIG’ LED lights at -20dBu to indicate signal presence, the yellow ‘0’ LED indicates normal level, and the red ‘PEAK’ LED warns of potential overload 5dB before clipping.

# FLIGHTCASING THE CONSOLE

If the console is to be regularly moved we recommend that it is installed in a foam-lined flightcase. At all times avoid applying excessive force to any knobs, switches or connectors.

Dimensions for flightcasing the console are shown below:

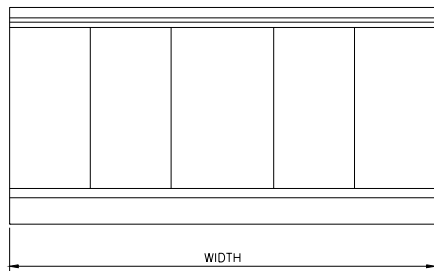

- GL2200 - 412.....width 548mm
- GL2200 - 416.....width 668mm
- GL2200 - 424.....width 920mm
- GL2200 - 432.....width 1160mm

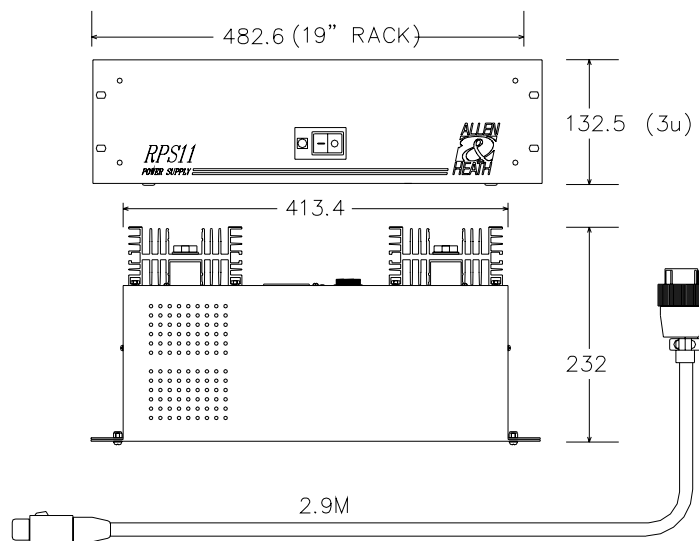
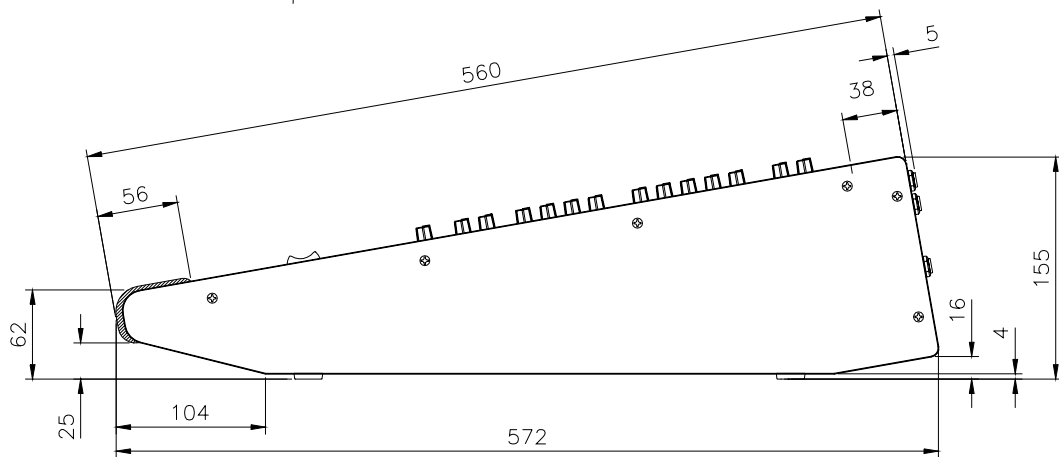

## DIMENSIONS

	Unpacked				Packed			
	Width	depth	height	weight(kg)	Width	depth	height	weight(kg)
GL2200-412.....	548	572	155	16	700	750	280	20
GL2200-416.....	668	572	155	18	815	750	280	23
GL2200-424.....	920	572	155	24	1065	750	280	29
GL2200-432.....	1160	572	155	30	1325	750	280	35
RPS11 power supply.....	483	232	135	9.5	575	270	170	11



**Avoid storing or using the RPS11 in conditions of excessive heat or cold. Position the RPS11 power supply away from the mixing console to avoid interference.**

# MONO INPUT CHANNEL

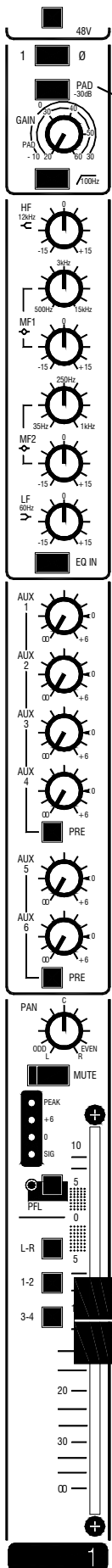

The mono input channel is designed using a very high quality analogue signal path to ensure absolute sonic purity for microphone or line level sources.

**MIC INPUTS** Plug a microphone source into the XLR input. If you leave the jack input unplugged then the **PAD (LINE)** switch becomes a 30dB pad for the microphone. This lets you use the XLR input for high output microphones, or for line level sources.

**LINE INPUTS** Plug a line level source into either the XLR or the TRS jack input. If you use the XLR input make sure that you do not plug anything into the jack input, and that you press the **PAD (LINE)** switch. If you use the TRS jack input make sure that you press the **PAD (LINE)** switch. The jack input is only selected with this switch pressed.

**48V** selects +48V to the XLR input for microphones that require phantom power.

**IMPORTANT NOTE :** Switch off channel +48V when non-phantom powered mic, line or unbalanced sources are to be used with the inputs.

$\phi$  reverses the **POLARITY** of the input source to correct the problems often encountered in microphone placement, or due to incorrectly wired cables (pin 3 hot instead of pin 2). May also helpful in reducing acoustic feedback between closely positioned loudspeakers and mics in live sound mixing.

**PAD (LINE)** selects the line level jack input when pressed or becomes a 30dB pad for the XLR input when no jack is plugged in. The XLR is normalled through the unplugged jack contacts. See MIC/LINE description above.

**GAIN** matches the level of the input source to the normal operating level of the console. Adjust this to read an average '0dB' on the channel meter (yellow LED). Use the **PFL** system to listen to the signal and fine tune the gain.

**100Hz** 18dB/Octave lo-cut filter removes low frequency noise such as microphone pops, proximity effect, stage noise and transport rumble after the pre-amp stage. It can also be used to clean up sounds that do not have much bass content, such as vocals and cymbals. The lo-cut filter is independent of the equaliser.

The 4-band **EQ** lets you adjust the tonal quality of the sound. The **HF** (treble) and **LF** (bass) bands have a shelving response, which means that all frequencies beyond the corner frequency are affected. Used with the 100Hz lo-cut filter you can tailor the low frequency response exactly as you require. The centre flat position is detented for quick resetting.

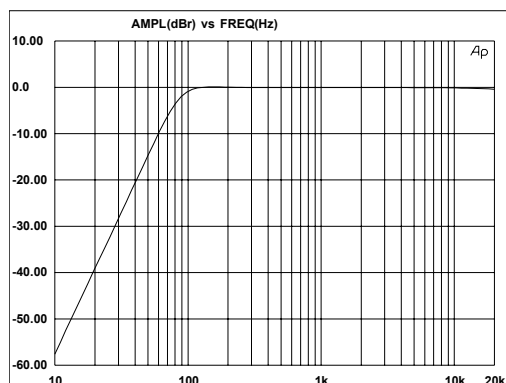

100 Hz lo-cut filter

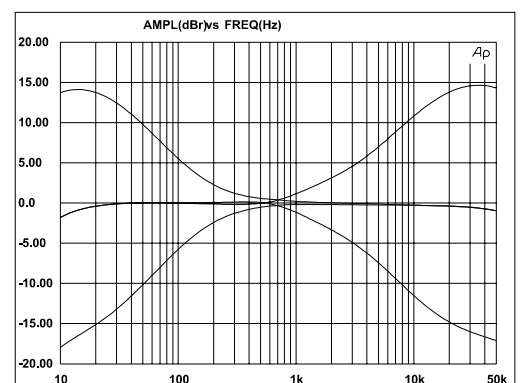

HF and LF EQ

The 2 mid frequency bands **MF1** and **MF2** can be swept across a wide frequency range to tune into the exact frequency required; useful for getting the best out of microphones or for tuning out troublesome feedback. The mid bands are overlapping with a Q of 1.6 and can boost or cut in excess of +/- 15dB. The centre flat position is detented for quick resetting.

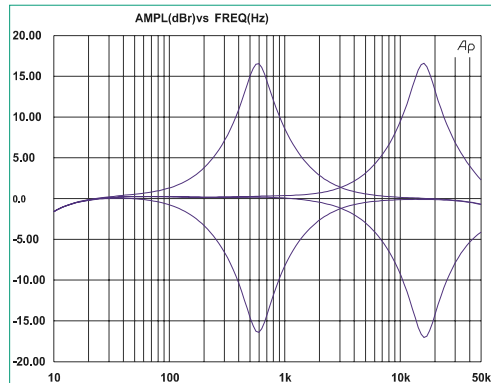
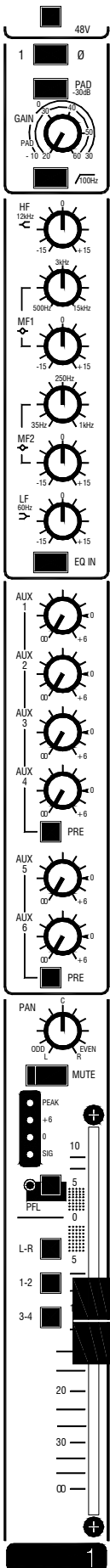

**MF1 EQ**

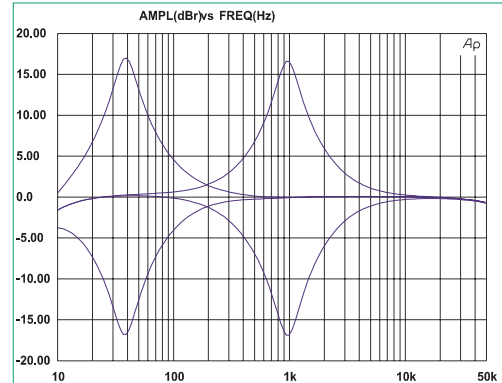

**MF2 EQ**

Press **EQ IN** to switch the EQ into the signal path.

**6 AUX SENDS** provide feeds for foldback monitors and effects. **Aux 1-4** and **Aux 5-6** may be set to pre or post-fader using the **PRE** switch.

Monitor sends to the performers are usually set pre-fade (**PRE**), although some sources such as radio mics are often set post-fade to avoid 'dressing room' talk spill.

Effects sends to external signal processing equipment such as reverb and delay effects units, are usually set post-fade so that the amount of effect (wet signal) is always relative to the position of the fader (dry signal).

Adjust the amount of effect required for each channel using its **AUX** control.

The effect is returned to the mix through another channel, usually the stereo return described later in this guide.

**POST-FADE** sends are post-EQ, post-mute. **PRE-FADE** sends are set post-EQ, post-mute as standard. Internal link options are available to change the source of the pre-fade sends. Refer to the internal link options section in this user guide.

**Note; AUX 1-6 feed XLR outputs with inserts when the GRP/AUX REVERSE switches are pressed in the master section.**

**PAN** positions the channel signal within the stereo image or between L-R and the groups when the routing switches are selected. The centre position is detented for quick resetting.

**MUTE** switches the signal off when pressed regardless of fader position. Muted channels are indicated by red LEDs. The channel meter continues to indicate pre-fader channel activity.

A 4 LED **CHANNEL METER** shows signal activity at all times. The green **SIG** LED indicates signals greater than -20dBu, yellow **'0'** and **'+6'** represents normal operating level, and red **PEAK** warns of potential overload 5dB before clipping. Set the channel signal so that the meter averages between **'0'** and **'+6'**. Back the gain off if the red peak LED flashes.

Pressing **PFL** lets you listen to the channel pre-fader signal on headphones without interrupting the main console outputs. The signal level is shown on the **L-R** bargraph meters. In this way each sound can be correctly lined up and checked at any time.

**L-R, 1-2, 3-4** routing switches feed the channel signal to the L-R mix and groups 1-2, 3-4. Use the pan control to route to individual groups, i.e. left to route to L, 1, 3 and right to route to R, 2, 4. In this way subgroups may be set up in mono or stereo to feed the main L-R mix.

A 100mm **FADER** provides +10dB boost above the normal '0' operating level. All post-fade aux send levels are dependent on the level of the fader.

# STEREO INPUT CHANNEL

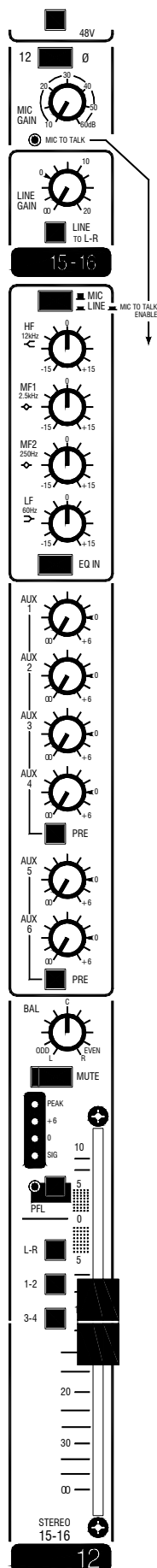

Two stereo input channels are included as standard. Each features a 4-band EQ, 6 aux sends and group routing. Use this channel for stereo sources such as keyboards and two track players, or for returning additional effects processors to the mix and monitors. A mic input is included so that you can use the channel for additional mics when needed. The stereo line input can still be routed to the mix while using the channel mic input.

The stereo inputs are on separate TRS jacks. For mono line sources plug into the L/MONO jack socket only. For microphone sources plug into the XLR.

**48V** selects +48V DC to the XLR input for microphones that require phantom power.

**IMPORTANT NOTE :** Switch off channel +48V when non-phantom powered or unbalanced sources are connected to the XLR input.

$\phi$  reverses the **POLARITY** of the input source to correct problems often encountered in microphone placement, or due to incorrectly wired cables (pin 3 hot instead of pin 2). May also be helpful in reducing acoustic feedback between closely positioned loudspeakers and mics in live sound mixing.

**GAIN** controls for the **MIC** and **LINE** inputs let you adjust each source independently.

**LINE TO L-R** routes the stereo line source direct to the L-R mix. In this way both the mic and stereo line inputs may be used at the same time. The mic can be routed through the stereo channel while the line input becomes an independent source or return to the LR mix.

**MIC/LINE** selects either the mic XLR or the stereo line jack inputs to the channel. When selecting **LINE** on the **second stereo input channel**, the MIC input section is available as the source for talkback. A green LED indicator illuminates to confirm this. The channel can be used with the stereo line input in the normal way while the mic is independently used for talkback.

The 4-band stereo **EQ** lets you adjust the tonal quality of the sound. The **HF** (treble) and **LF** (bass) bands have a shelving response, which means that all frequencies beyond the corner frequency are affected. The 2 mid frequencies **MF1** and **MF2** provide optimum control over boomy or boxy sounds (250Hz), and can add bite or reduce harshness to keyboards, vocals etc. (2.5kHz). The centre flat position is detented for quick resetting.

**6 AUX SENDS** provide feeds for foldback monitors and effects. **Aux 1-4** and **Aux 5-6** may be set to pre or post-fader using the **PRE** switch. The left and right stereo signals are summed to provide aux feeds in mono.

Monitor sends to the performers are usually set pre-fade (**PRE**), although some sources such as radio mics are often set post-fade to avoid 'dressing room' talk spill.

Effects sends to external signal processing equipment such as reverb and delay effects units, are usually set post-fade so that the amount of effect (wet signal) is always relative to the position of the fader (dry signal).

Adjust the amount of effect required for each channel using its **AUX** control.

The effect is returned to the mix through another channel, usually the stereo return described later in this guide.

**POST-FADE** sends are post-EQ, post-mute. **PRE-FADE** sends are set post-EQ, post-mute as standard. Internal link options are available to change the source of the pre-fade sends. Refer to the internal link options section in this user guide.

**Note;** **AUX 1-6** feed XLR outputs with inserts when the **GRP/AUX REVERSE** switches are pressed in the master section.

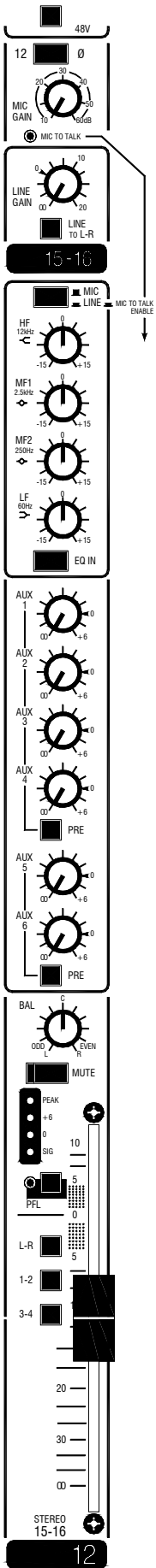

**BAL** positions the channel signal within the stereo image or between L-R and the groups when the routing switches are selected. The centre position is detented for quick resetting.

**MUTE** switches the signal off when pressed regardless of fader position. Muted channels are indicated by red LEDs. The meter continues to indicate pre-fader channel activity.

A 4 LED **CHANNEL METER** shows signal activity. The green **SIG** LED indicates signals greater than -20dBu, yellow **'0'** and **'+6'** represents normal operating level, and red **PEAK** warns of potential overload 5dB before clipping. Set the channel signal so that the meter averages between **'0'** and **'+6'**. Back the gain off if the red peak LED flashes.

Pressing **PFL** lets you listen to the channel pre-fader signal on headphones without interrupting the main console outputs. The signal level is shown on the **L-R** bargraph meters. In this way each sound can be correctly lined up and checked at any time.

**L-R, 1-2, 3-4** routing switches feed the channel signal to L-R mix and groups 1-2, 3-4. Use the pan control to route to individual groups, ie left to route to L, 1, 3 and right to route to R, 2, 4. In this way subgroups may be set up in mono or stereo to feed the main L-R mix.

A 100mm **FADER** provides +10dB boost above the normal **'0'** operating level. All post-fade aux send levels are dependent on the level of the fader.

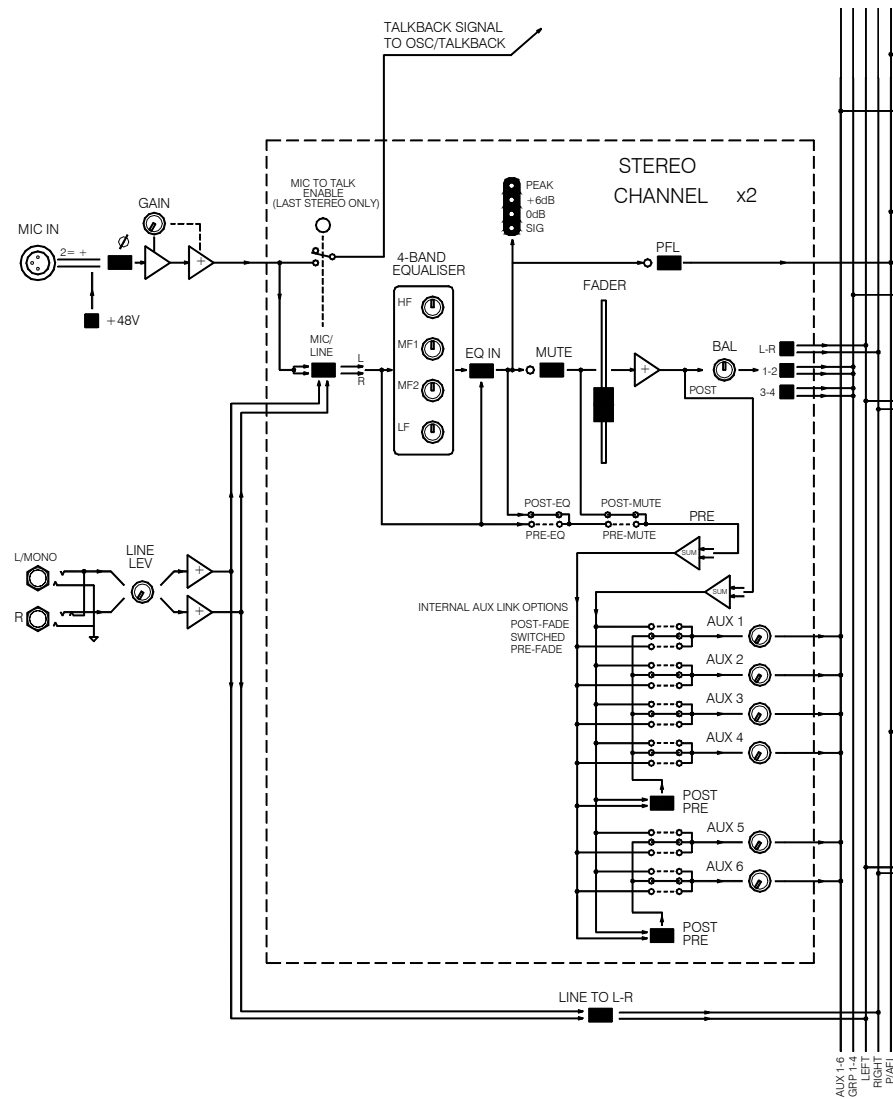

The stereo input diagram showing the talkback and stereo line signal routing.

# STEREO RETURNS

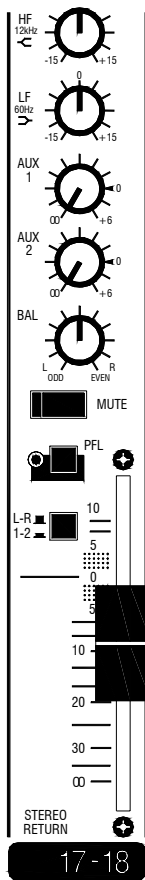

Two stereo return inputs are provided with 2-band EQ, sends to auxes 1 & 2 and routing to **L-R** mix or groups **1-2/3-4**. These are normally used to return the effects ('wet') signal, usually from a stereo device, to the mix. They can also be used for additional line inputs to the mix.

A 2 band **EQ** provides **HF** and **LF** control with 15dB cut and boost at 12kHz and 80Hz respectively. This is often used to remove unwanted high or low frequency noise from effects devices.

2 aux sends are provided to feed a summed left and right pre-fade post mute signal to auxes 1 & 2. This is ideal for returning effects to the monitors without using up valuable channel inputs.

The **BAL** control adjusts the balance between left and right signals, or can be used as a pan control to route the signal to one side only by rotating fully.

**MUTE** switches the signal off when pressed regardless of fader position. Muted Returns are indicated by red LEDs. Mute does affect the pre-fade aux sends.

Pressing **PFL** lets you listen to the channel pre-fader signal on headphones without interrupting the main console outputs. The signal level is shown on the **L-R** bargraph meters. In this way each sound can be correctly lined up and checked at any time.

**L-R/1-2 (3-4) ROUTING SWITCHES** - In the up position the signal is routed to the main **L-R** mix but may be returned to the corresponding pairs of subgroups for group effects (**1-2** or **3-4**).

A smooth travel 60mm **FADER** provides precise control of the level.

# AUX OUTPUTS

## AUX MASTERS

Each aux mix has a master level control that adjusts the output level to match external equipment, or to trim the monitor or effects level without affecting the mix balance. Up to +10dB of boost is available above the nominal '0' position. Auxiliary outputs are on 3-wire impedance balanced 1/4" TRS jacks.

**AFL** (After Fade Listen) routes the post mix signal to the console meters and headphone monitoring to allow checks for sound quality and mix level.

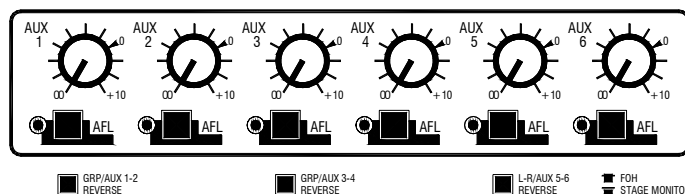

If **MODE SWITCHING** aux/groups reverse is in operation, aux master level controls are connected to the corresponding group busses (Group 1 to Aux Master 1, etc...). Refer to **MODE SWITCHING** section on page 17 for more information

# GROUP OUTPUTS

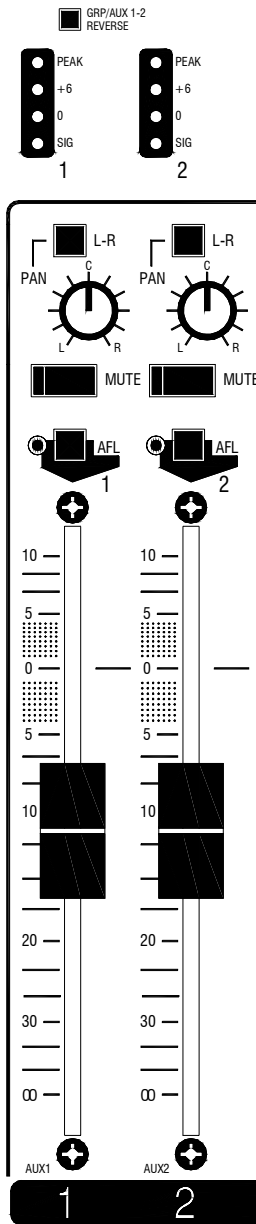

## GROUPS

Group outputs are controlled by 100mm travel faders which offer a further 10dB boost above the normal '0' dB operating level.

**MUTE** switches the group signal off when pressed regardless of fader position. Muted channels are indicated by red LEDs.

**AFL** (After Fade Listen) routes the post fader signal to the console meters and headphone monitoring to allow checks for sound quality and mix level. The AFL signal is sourced before the MUTE switch allowing the signal to be checked even when the group is muted.

Each group has a 4 segment LED peak reading meter providing signal presence indication and peak warning which illuminates approximately 5dB before clipping. Meter activity is interrupted when a group is muted.

## SUB GROUPING

Sometimes it is necessary to control more than one channel simultaneously, in the case of a drum kit or a group of backing vocalists for example.

Route the relevant channels to groups instead of L-R, using the channel routing switches and the pan controls.

**PAN** control positions the signal in the stereo image with the **L-R** switch routing the group mix to the Left & Right masters. Ensure the group **L-R** switch is selected to route the group signal to the L-R mix.

In this way, one group fader can control the level of several channels.

It is possible to set up mono or stereo subgroups using the channel and group PAN controls.

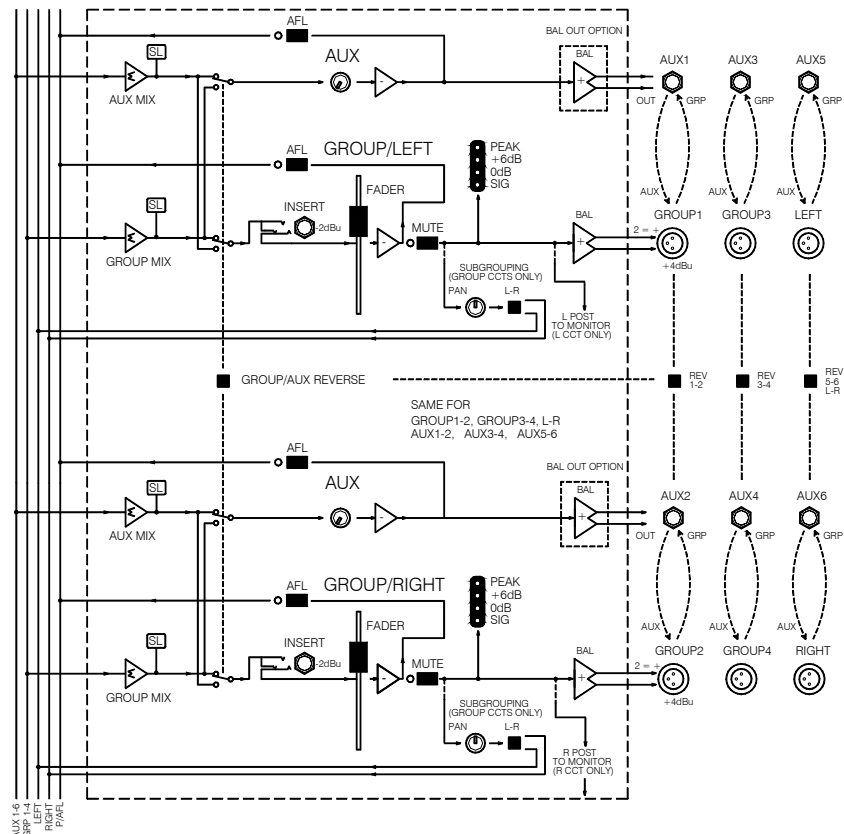

Group / Aux diagram



# MODE SWITCHING

The **GL2200** features a set of **GROUP/AUX REVERSE (REV)** switches, which can transpose the **AUX** and **GROUP** controls in pairs. These switches are recessed to avoid accidental operation. Set using a pointed object or a pen tip.

This feature allows you to set the operation of the console for Front Of House, Stage monitor or a combination of both (Dual mode).

With the switches out, the groups operate in the conventional manner, channel grouping using the channel routing switches.

When the **REVERSE** switches are pressed in, the group busses are routed to the **AUX send masters** and the aux busses are routed to the **GROUPS** (Aux 1 to Group 1, etc.). **Aux 5 & 6** are routed to **L-R** faders respectively.

This configuration allows the user to control up to six monitor mix levels on faders. Outputs are on balanced XLRs for long cable runs and a signal processor (equaliser, compressor, limiter, etc.) can be inserted into the signal path using the group and left/right **INSERT** jacks.

The L-R and group busses are still operational but are now routed to the aux master controls and can be used for additional monitor or effect sends.

It is advisable to study the **GL2200** block diagram to fully understand this flexible routing arrangement.

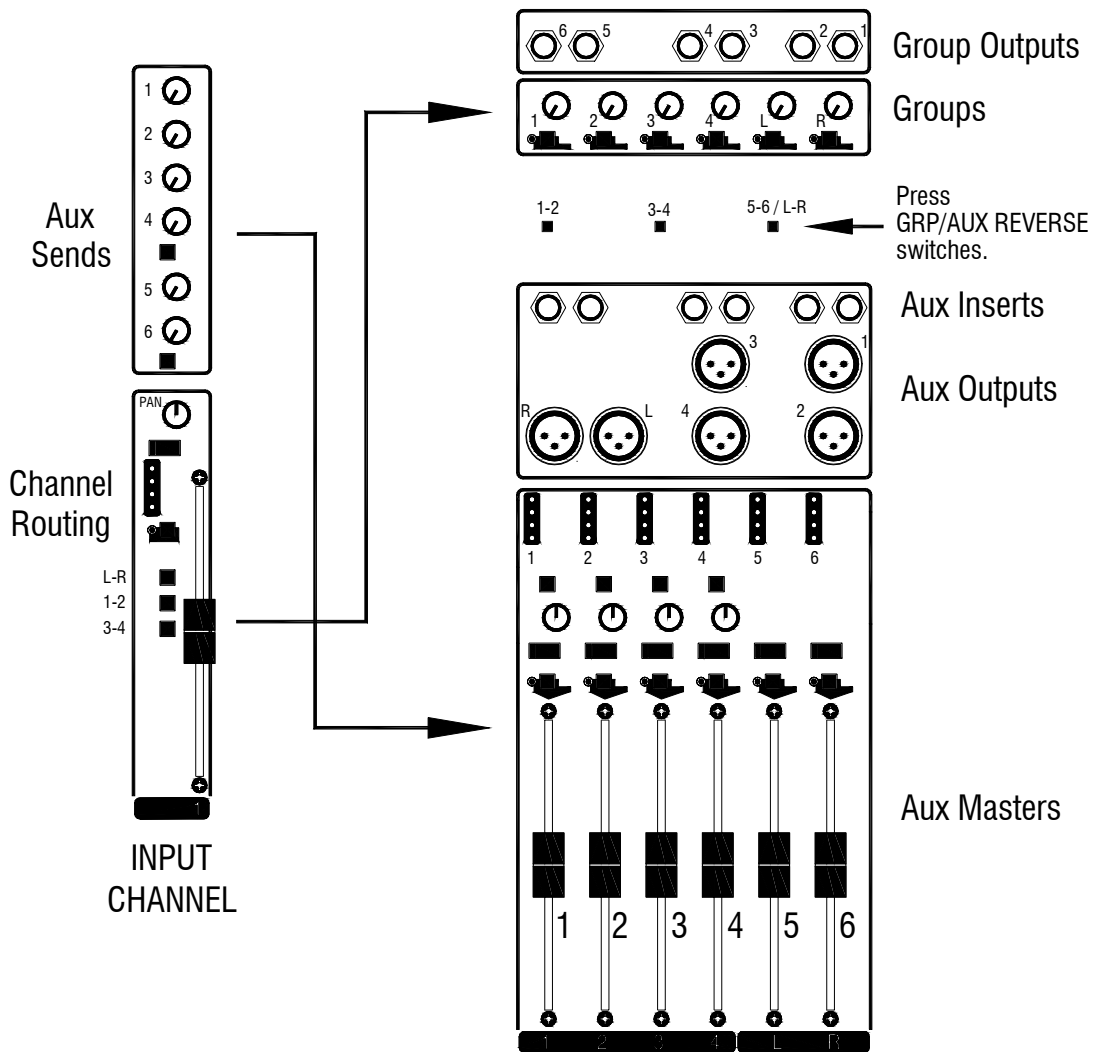

**Aux and Groups reversed**

# MASTER & MONITOR

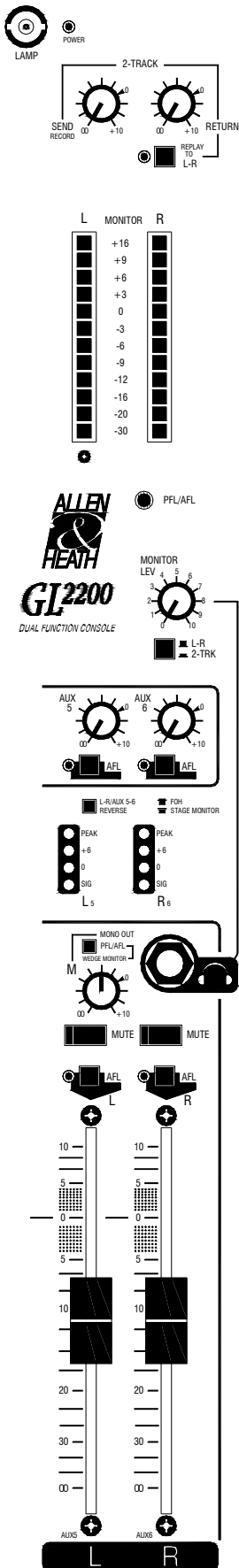

## LAMP

Plug in a standard 12V “gooseneck” lamp to provide illumination of the control panel. This should be a BNC connector type with a current consumption of no more than 350mA.

## 2-TRACK RECORD AND REPLAY

Individual RCA phono sockets are provided for connecting a 2-track stereo recorder such as a cassette or DAT machine. Connect the recorder input (REC) connectors to the console SEND sockets and the recorder output (PLAY) connectors to the RETURN sockets

Separate **SEND** and **RETURN** level controls adjust the signal to the required line level and sensitivity. The console can work with both high (+4dBu) and low (-10dBV) level equipment.

Alternatively the RETURN inputs may be used for stereo intermission replay from a CD or similar to the main mix by pressing **REPLAY TO L-R**. An LED warns that replay is selected.

The SEND may be used for recording or broadcasting the performance in stereo, or to feed an alternative set of speakers, or drive an induction loop hearing aid system. The send outputs are post L-R faders as standard.

## PHONES MONITOR AND BARGRAPH METERS

Use stereo headphones with a nominal impedance of 30 to 600 ohms. Adjust the **LEV** control for a comfortable listening level. The phones and the 12 segment bargraph normally meter the post fade L-R mix or the two track return depending on the position of the **L-R/2TRK** switch. Pressing any **AFL/PFL** button on the console will override the monitor with the selected AFL/PFL signal. A large red LED located below the meters indicates a **PFL** or **AFL** selection.

## MONO OUTPUT

The **MONO OUT / AFL/PFL** switch sources the signal from either a summed post-fader L-R mix or the AFL/PFL mix. When **MONO OUT** is selected, the MONO output provides for a centre fill or sub-bass loudspeaker, mono recording or broadcast feed. When **AFL/PFL** is selected, you can feed a stage monitor engineer’s listen wedge.

This switch is recessed to avoid accidental operation. Use a pointed object or pen tip to operate.

## MAIN L-R OUTPUTS

**MUTE** switches the main mix signal off when pressed regardless of fader position. Muted outputs are indicated by red LEDs.

**AFL** (After Fade Listen) routes the post fader mix signal to the console meters and headphone monitoring to allow checks for sound quality and mix level. The **AFL** signal is sourced before the **MUTE** switch allowing the signal to be checked even when the mix signal is muted.

**L-R FADERS** - Individual 100mm faders adjust the main L-R mix level with +10dB boost available above the nominal ‘0’ position. For best performance the faders should be operated around the ‘0’ position for normal ‘loud’ level. If you find yourself operating significantly below ‘0’ then the amplifier or recorder input is too sensitive for the console +4dBu output. Simply turn down the amplifier or recorder level trim. If none is available then insert an attenuator pad between the console and connected equipment.

# OSCILLATOR/PINK NOISE & TALKBACK

The **GL2200** oscillator section provides for two modes of operation:

## 1kHz Tone Mode

A 1kHz sinewave is provided for setting up input levels on external devices, such as recording equipment, FX processors and so on.

## Pink Noise Mode

A 'pink noise' signal, can be used to check the phase and overall frequency response of a loudspeaker or an array of loudspeakers or for analysing the acoustics of an auditorium. Pink noise produces equal sound energy per octave over the audio band. It has a "mellow, balanced" sound to the human ear compared with white noise, which sounds "brilliant and hissy" due to additional energy at high frequencies.

## OSCILLATOR

**1kHz/Pink Noise** – Selects between the two signal types outlined above.

The **level** control allows adjustment from  $-20\text{dBu}$  to  $+20\text{dBu}$ .

When the **TALK** switch is pressed, the level of the oscillator/pink noise is reduced by 12dB.

**L-R, GRP 1-4, AUX 1-2, AUX 3-4, AUX 5-6** routing switches assign the oscillator/pink noise and talkback to the required mix busses.

**ON** – Switches the oscillator/pink noise on and off. LED indicates status. Under-panel switch prevents accidental triggering of the oscillator during performances.

**WARNING!** – The oscillator/pink noise facility on the **GL2200** is a powerful tool for audio system checking and setup. However, the operator should ensure that the **ON** switch is not selected during performances in order to avoid interruption of the show and possible speaker damage by accidentally routing the oscillator to the outputs.

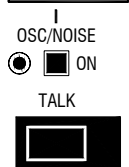
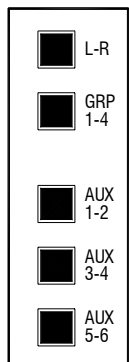
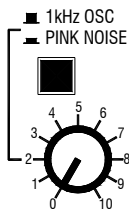

## TALKBACK

The talkback input is connected into the Mic input of the **SECOND STEREO INPUT CHANNEL**. By selecting **LINE**, the signal is fed to the routing switches in the oscillator/pink noise section and talkback is enabled when the momentary **TALK** switch is pressed. Talk to several destinations at the same time by selecting a combination of routing switches.

Use the **MIC GAIN** control on the stereo input channel to control talkback level.

**+48V** is available for microphones which require phantom power.

The ability to talk to auxes (foldback monitors) is important when using the console for stage monitoring and cueing the performers.

The line jack inputs of the second stereo input channel can still be used when the mic input is enabled for talkback.

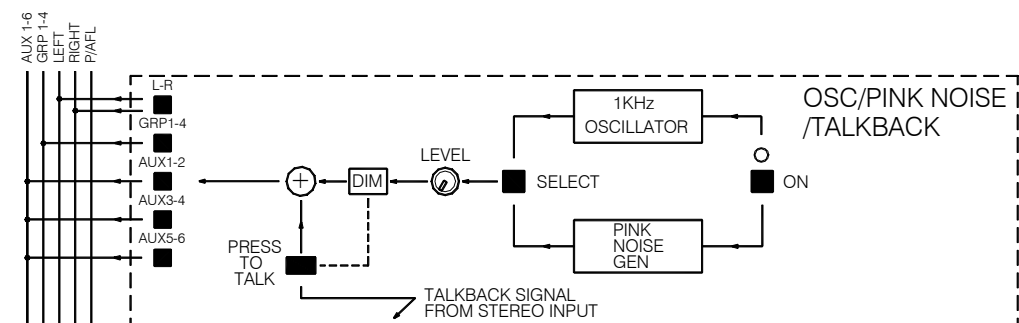

Oscillator / Pink noise generator and talkback section.

# FRONT OF HOUSE

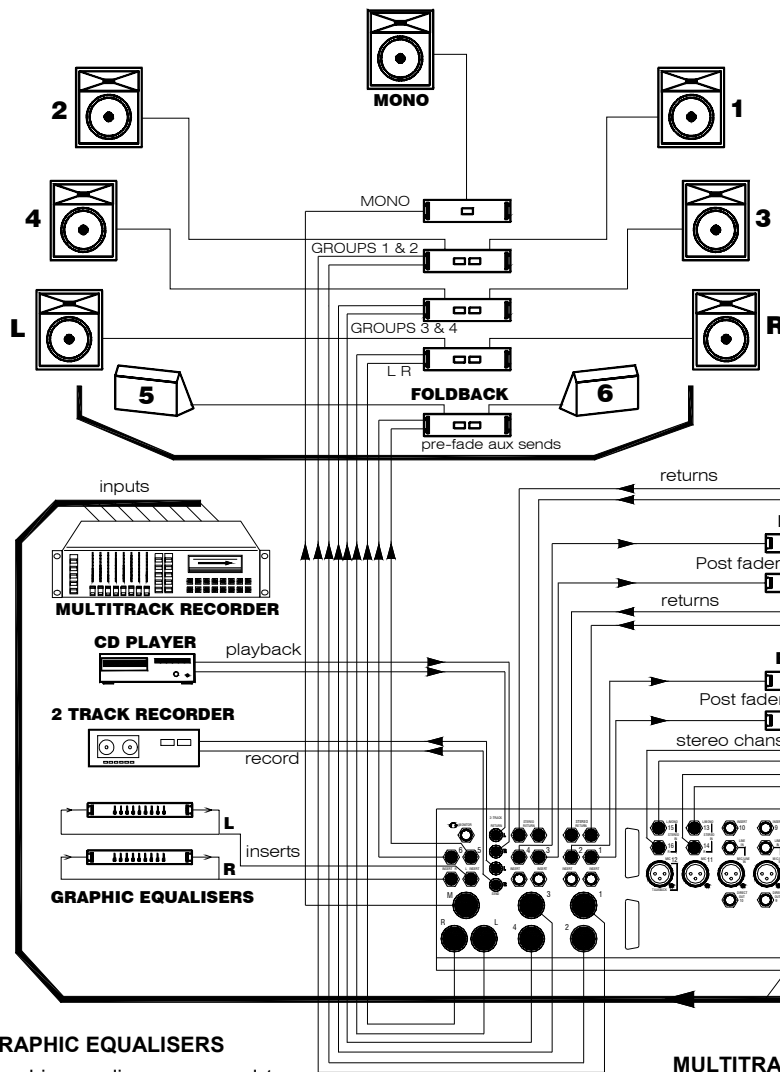

This example shows the 4 groups, L - R and Mono outputs feeding a 7-stack FOH amplification system. The groups provide independent control of the additional left and right loudspeaker stacks or may be used for zone feeds or for subgrouping to the L-R mix.

## INSERTS

The inserts on the channels and outputs may be used for outboard effects and signal processing devices such as compressors, limiters and graphic equalisers.

## GRAPHIC EQUALISERS

Graphic equalisers are used to compensate for adverse room acoustics. These devices help reduce acoustic feedback and enhance the clarity of the sound.

## MULTITRACK RECORDING

Connect the inputs of the multitrack to the channel direct out sockets to record each channel on a separate track for mix down later.

## 2-TRACK RECORDING AND INTERMISSION REPLAY

Use the console 2-track send and return sockets for connecting a cassette or DAT recorder and a CD player. Connect the CD player to the console two track return sockets for intermission replay. This does not affect the recording process.

## AUX SENDS

Select aux 1-4 post-fade to access 4 effects processing devices. Use the stereo returns and stereo inputs to add the effects to L-R and mono mix.

Select aux 5-6 pre-fader for foldback monitor sends.

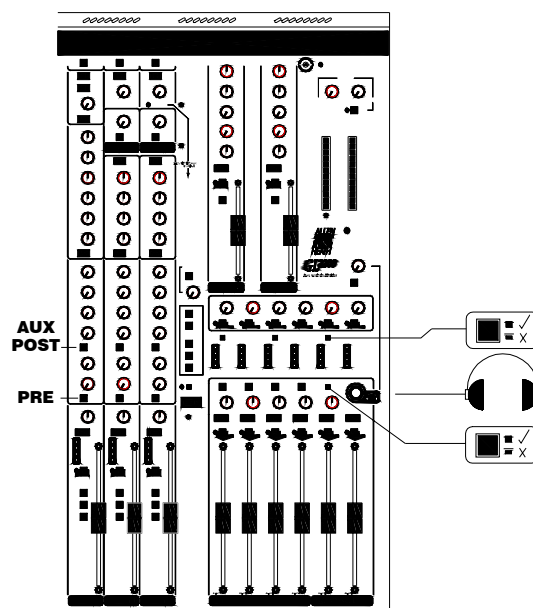

## AUX MASTERS

These switches are recessed to avoid accidental operation. Set using a pen tip or pointed object.

Set the **AUX REVERSE** switches to the up position for conventional aux/group operation

Set the **LR SUM MONO** switch to up for mono out (L+R sum)

# STAGE MONITOR

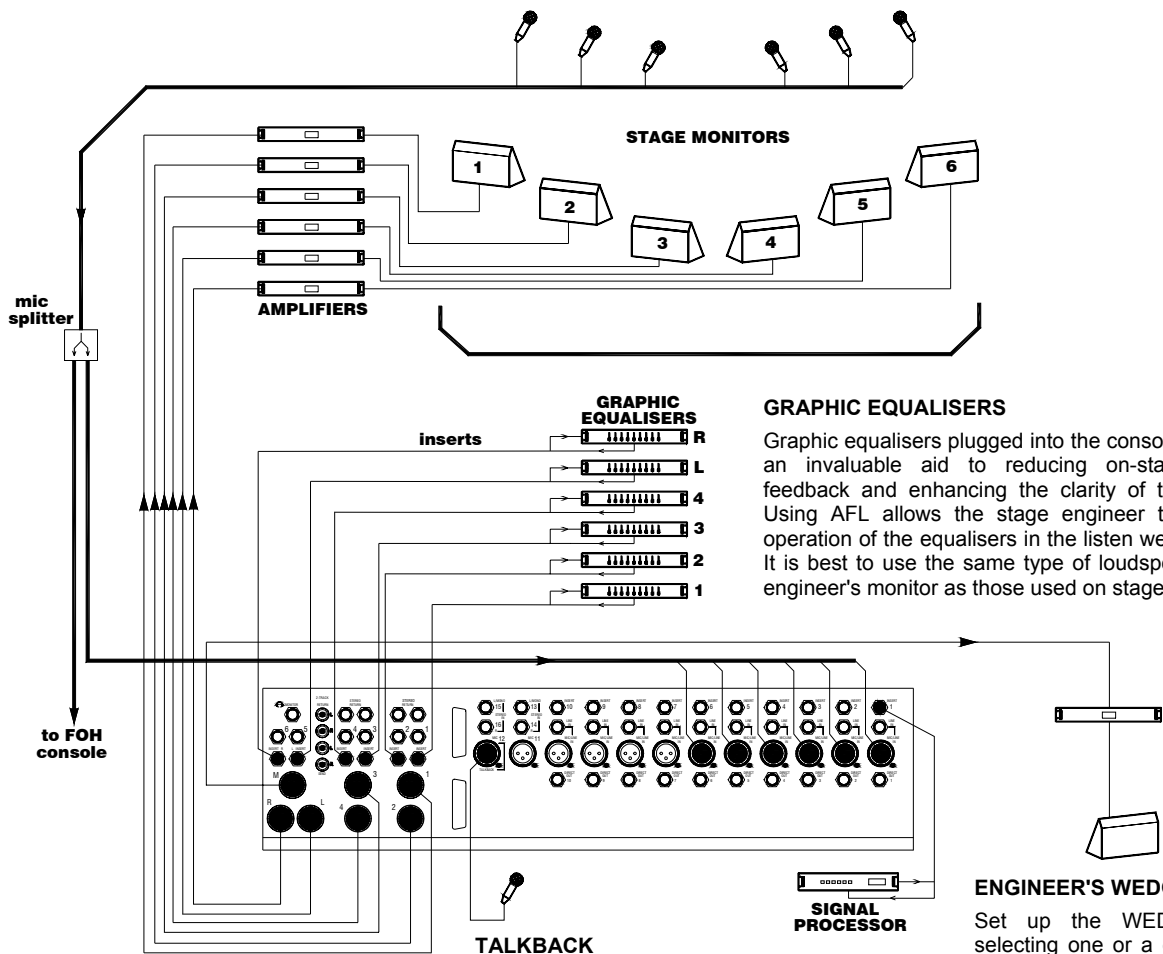

## GRAPHIC EQUALISERS

Graphic equalisers plugged into the console inserts are an invaluable aid to reducing on-stage acoustic feedback and enhancing the clarity of the monitors. Using AFL allows the stage engineer to check the operation of the equalisers in the listen wedge monitor. It is best to use the same type of loudspeaker for the engineer's monitor as those used on stage.

## TALKBACK

Selecting the GRP 1-4 and L-R switches in the **OSC/NOISE** section enables talkback to the performers using the stage monitors.

## ENGINEER'S WEDGE MONITOR

Set up the WEDGE MIX by selecting one or a combination of the groups/L-R AFL switches to listen to the desired monitor outputs. These are post insert and therefore post graphic EQ and post fader for accurate monitoring. Pressing any PFL or AFL switch allows channel set up and signal checking.

This example shows the 6 aux sends routed through the main groups and L-R outputs to provide 6 independent stage monitor mixes with metering, MUTE switches, inserts and balanced XLR connectors.

The **AUX/GROUP** reverse switches reroute the group and L-R mix to the aux jacks outputs for additional monitoring or effect sends or as independent submix facilities. For example, aux 5 and 6 jack outputs may provide a separate stereo mix output from the channel L-R routing switches and the additional 4 stereo return line inputs.

Use the groups to add effects such as delay, reverb or echo to the stage monitors.

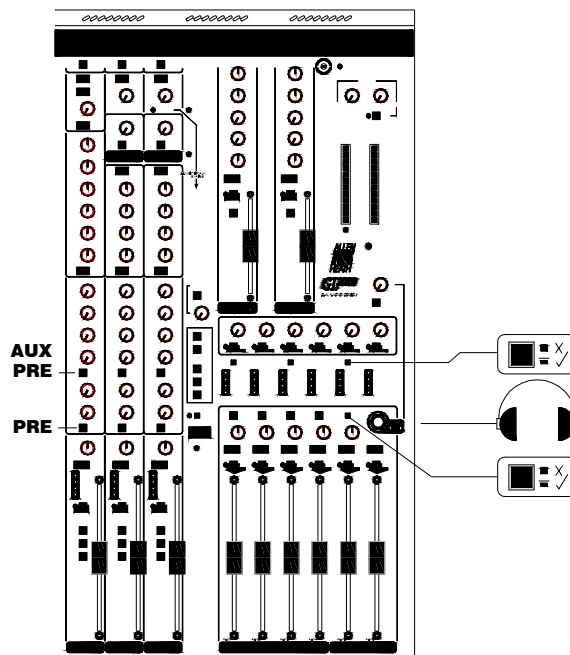

These switches are recessed to avoid accidental operation. Set using a pen tip or pointed object.

Set the **AUX REVERSE** switch to the down position (below panel) to route the aux mix through the groups and L-R XLR outputs for stage monitor level control with fader.

Set **LR SUM MONO** switch to down (below panel) for engineer's listen wedge following PFL/AFL.

# DUAL MODE

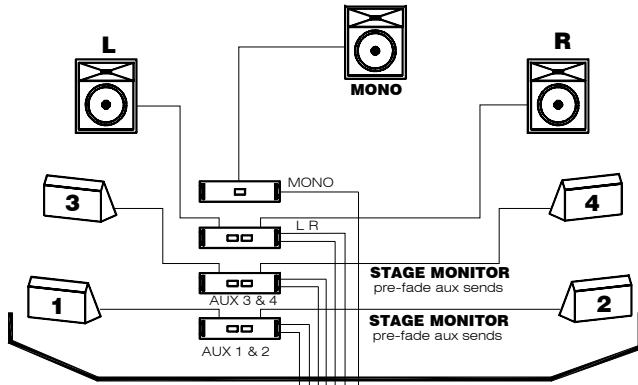

## MULTITRACK RECORDING

Connect the inputs of the multitrack to the aux jack outputs. These are now the group mix outputs. Any unused multitrack inputs can be connected to the channel direct out sockets to record each channel on a separate track for mix down later.



## COMPRESSORS/LIMITERS

These are used to prevent excessive peaks overloading the amplification system, for example in club installations subject to sound level control.

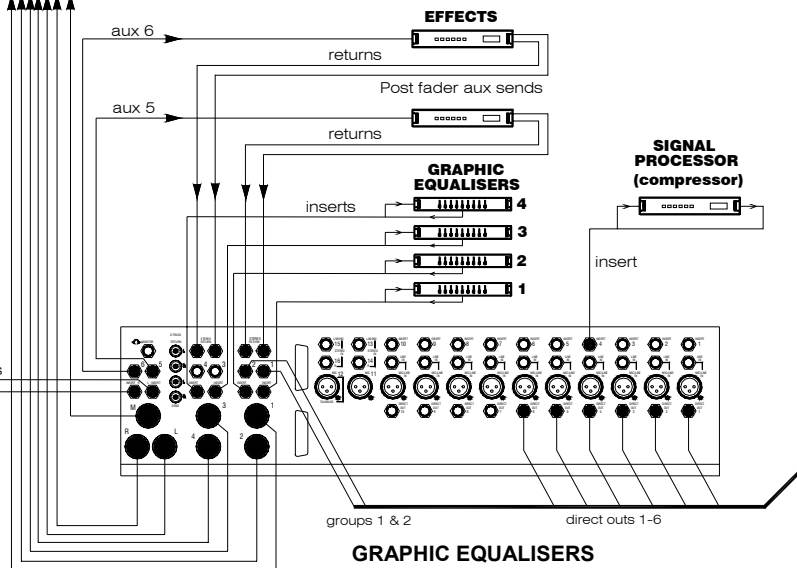
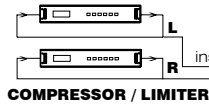

## GRAPHIC EQUALISERS

Graphic equalisers plugged into the inserts are an invaluable aid to reducing on-stage acoustic feedback and enhancing the clarity of the monitors.

This example shows the console configured to control a Left, Right and Centre Front of House system with 4 full feature stage monitor mixes.

Stage monitor sends aux 1-4 are set pre-fade so that the signal level is not affected by the fader position and the FOH mix.

Aux 5-6 are set post-fade to access two effects devices whose outputs are added to the L-R mix via stereo returns 1 and 2. Alternatively, these may be connected to the stereo channels.

The channel and output inserts may be used for outboard effects and signal processors such as compressors, limiters and graphic equalisers.

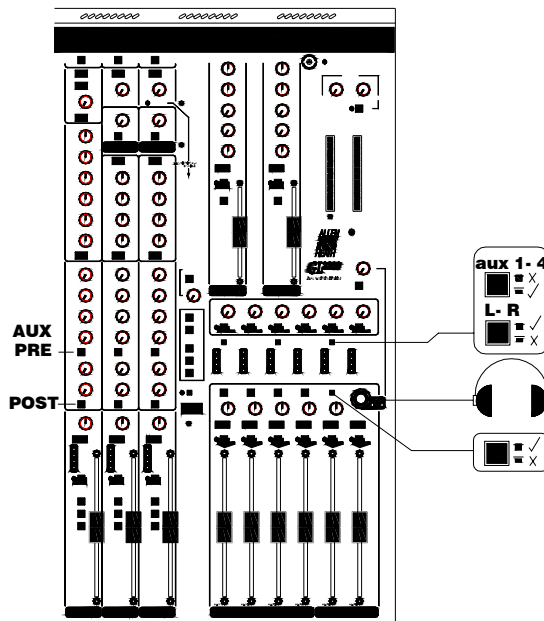

These switches are recessed to avoid accidental operation. Set using a pen tip or pointed object.

Set the **AUX REVERSE** switch to the down position (below panel) to route aux mixes 1-4 through groups 1-4. Set L-R switch in the up position for conventional operation.

Set **LR SUM MONO** switch to up for mono out (L+R sum).

# FRONT PANEL LAYOUT

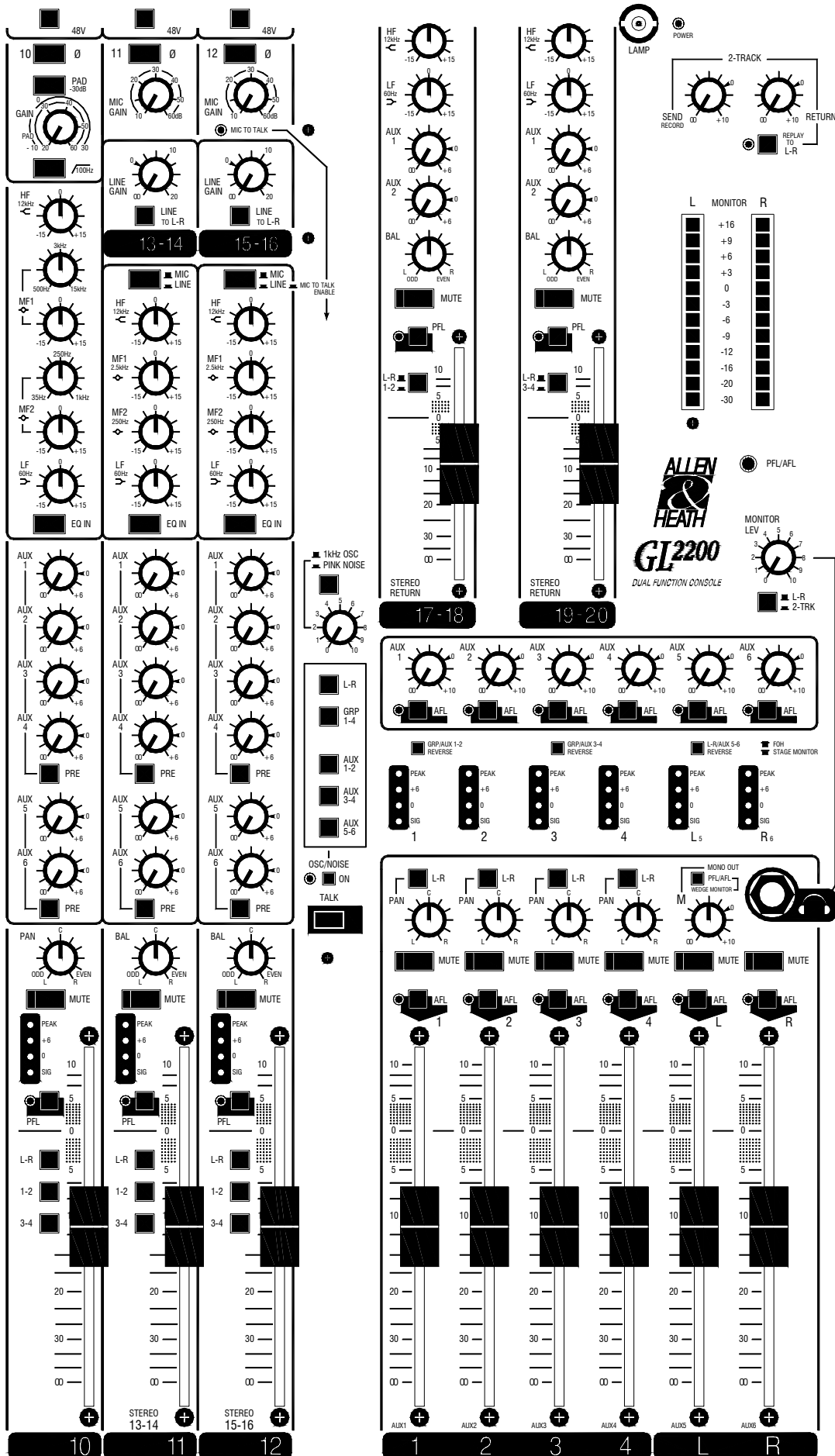

# REAR PANEL LAYOUT

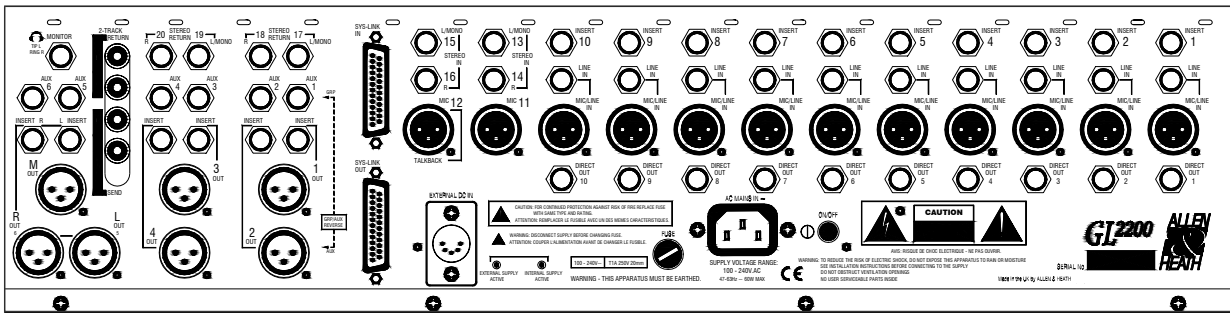

## SPECIFICATIONS

0 dBu = 0.775 Volts rms    0 dBV = 1 Volt rms

**HEADROOM:**..... +21dB

**MAX OUTPUT:** ..... XLR +25dBu 2kohm max load  
 ..... JACK +21dBu 2kohm max load

**METERS:** L, R.....peak reading 12 bar LED  
 Groups 1-4.....peak reading 4 segment LED  
 Channels.....peak reading 4 segment LED

**PEAK LEDs:** ..... Turn on 5dB before clipping

**FREQUENCY RESPONSE** referred to 1kHz @ +4dBu:  
 Any input to any output .....20Hz to 30kHz +0/-1dB

**DISTORTION:** THD+Noise @ +14dBu 1kHz  
 Mic in to L-R output, 40dB gain .....0.010%  
 Line in to L-R output, 0dB gain .....0.008%

**CMRR**  
 Mic in, 40dB gain @ 1kHz ..... >88dB

**CROSSTALK:** Referred to driven channel @ 1kHz  
 Adjacent channel ..... < -90dB  
 Channel fader off ..... < -90dB  
 Channel mute on ..... < -90dB  
 Channel Pan pot isolation ..... < -80dB

**NOISE:** Measured rms, 22kHz bandwidth  
 Mic input EIN (150 ohm source) ..... < -128dB  
 Line preamp, 0dB gain ..... < -83dBu  
 L-R output residual noise ..... < -92dBu (96dB S/N)  
 L-R faders '0', nothing routed ..... < -88dBu (92dB S/N)  
 L-R mix noise (16 channels routed) ..... < -83dBu (87dB S/N)  
 Group, faders '0', nothing routed ..... < -91dBu (95dB S/N)  
 Group mix noise (16 channels routed) ..... < -83dBu (87dB S/N)

**POWER SUPPLY:** ..... 100 to 240V AC @ 47/63Hz  
 ..... Internal, autosensing AC mains input  
 Power consumption: ..... 60W max  
 Mains Fuse rating 100-240VAC: ..... T1A 250V 20mm

## CONNECTIONS

### INPUTS:

Mic in.....	XLR.....	pin 2 hot, 3 cold, balanced	>2k Ohm	variable -60 to -20dBu
Line in .....	XLR.....	pin 2 hot, 3 cold, balanced	>10k Ohm	variable -30 to +10dBu
	or TRS jack .....	tip hot, ring cold, balanced	>10k Ohm	variable -30 to +10dBu
Stereo Ch Line in .....	TRS jack .....	tip hot, unbalanced	>8k Ohm	-20dBu min
Stereo Return .....	TRS jack .....	tip hot, unbalanced	>6k Ohm	-10dBV min
2-Track Return .....	RCA PHONO .....	unbalanced	>10k Ohm	-10dBV min
Insert Return .....	TRS jack .....	tip send, ring return, unbalanced	>6k Ohm	0dBu (chan), -2dBu (out)

### OUTPUTS:

L-R, Group out .....	XLR.....	pin 2 hot, 3 cold, balanced	<75 Ohm	+4dBu, +27dBu max
Direct out .....	TRS jack .....	tip hot, impedance balanced	<75 Ohm	0dBu
2-Track sends .....	RCA PHONO .....	unbalanced	<75 Ohm	variable +21dBu max
Aux out.....	TRS jack .....	tip hot, impedance balanced	<75 Ohm	variable +21dBu max
Mono out.....	XLR.....	pin 2 hot, 3 cold, balanced	<75 Ohm	+4dBu, +27dBu max
Insert send .....	TRS jack .....	tip send, ring return, unbalanced	<75 Ohm	0dBu (chan), -2dBu (out)
Monitor out.....	TRS jack .....	tip left, ring right, unbalanced	<75 Ohm	variable +21dBu max
Phones out.....	TRS jack .....	tip left, ring right.....		for stereo headphones 30 to 600 Ohms



# INTERNAL LINK OPTIONS

The console is set to satisfy most applications that should be encountered. However, the following internal link options are offered to provide alternative settings for those applications that may require them. These options involve resoldering of circuit board links and should only be carried out by competent technical personnel. Further information is available in the **GL2200 SERVICE MANUAL** and from your agent.

## MONO & STEREO INPUT

1. Reconfigure each aux as required to be **permanently pre-fade or post-fade** rather than switched by the front panel **PRE** switch.
2. Reconfigure the pre-fade sends to be **pre-EQ / pre-mute**, or **post-EQ / pre-mute**, instead of the standard post-EQ / post-mute.
3. **Disable +48V** phantom power regardless of panel switch position - remove link.
4. Reconfigure the Direct Out Source to be **pre-fade or post-fade**.

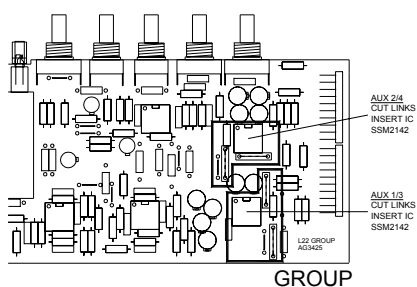
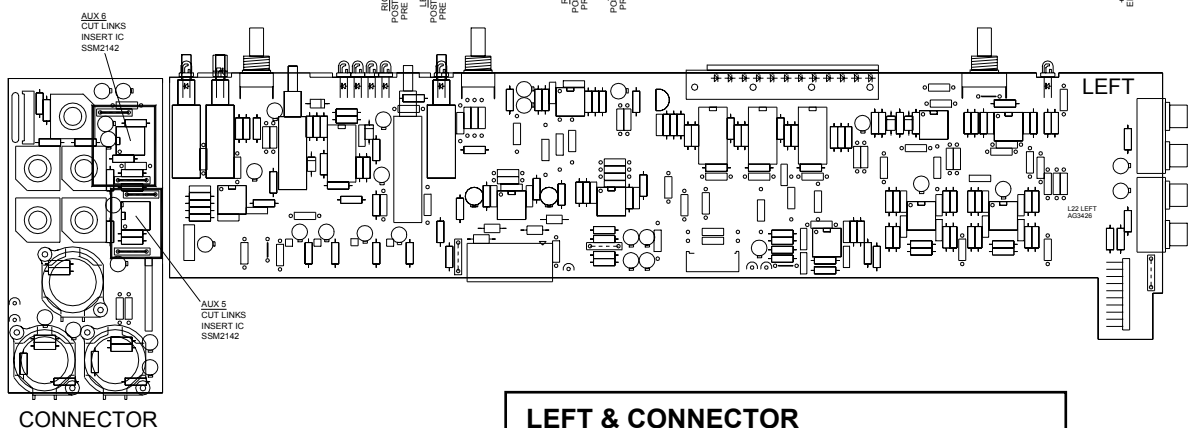
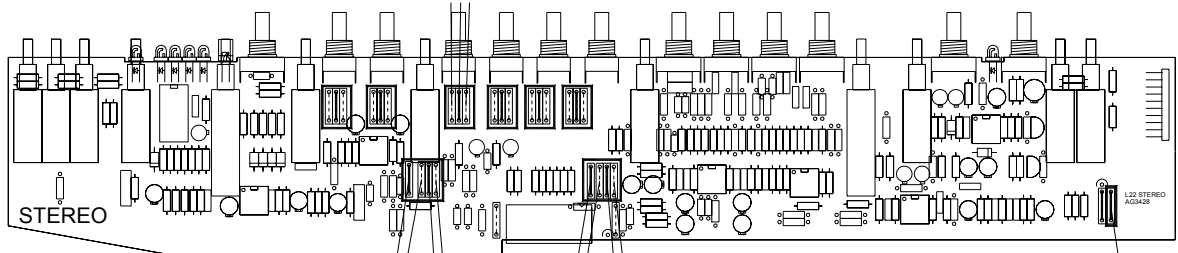
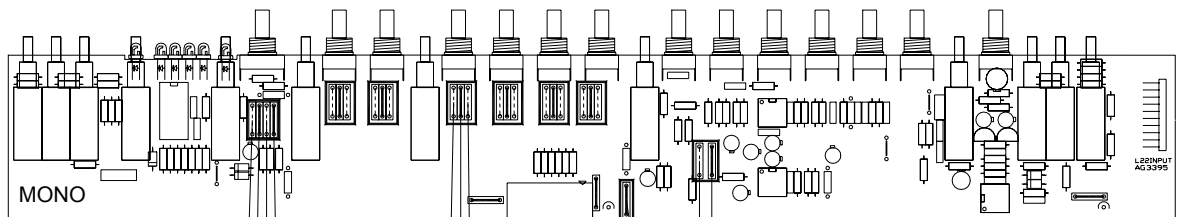

**LEFT & CONNECTOR**  
 For Aux out 5 & 6 balance option with jack output tip = hot, ring = cold. Remove two links and plug in balance driver IC.

**GROUP**  
 For Aux out 1-4 balance option with jack output tip = hot, ring = cold. Remove two links and plug in balance driver IC.





# GL2200 CUE SHEET – MASTER & INPUTS

Copy this sheet and use it to record the console settings.

The diagram illustrates the control panel of the Allen & Heath GL2200 console, divided into Master and Input sections.

**Master Section (29-30, 31-32):**

- 29-30:** Includes HF OSC, PINK NOISE, STEREO RETURN, AUX 1-5, BAL, MUTE, PFL, L-R, and SPK 1-4.
- 31-32:** Includes HF OSC, PINK NOISE, STEREO RETURN, AUX 1-5, BAL, MUTE, PFL, L-R, and SPK 1-4.
- MONITOR:** Features L and R monitors with level meters ranging from -30 to +16 dB.
- GL2200:** Branding and model name.

**Input Section (17-24):**

- Inputs 17-24:** Each input channel includes a 48V PAD, GAIN, HF OSC, MFT, EQ (500Hz, 1000Hz, 5000Hz), V/F, LF, and EQ IN controls.
- AUX 1-6:** Auxiliary send controls for each input channel.
- PAN:** Pan controls for each input channel.
- MUTE:** Mute controls for each input channel.
- PEAK, SIG, PFL:** Monitoring indicators for each input channel.
- L-R, 1-2, 3-4:** Stereo and sub-stereo routing options for each input channel.

NOTES:

